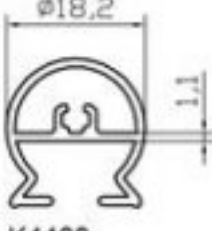
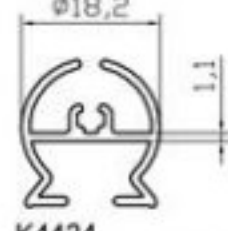
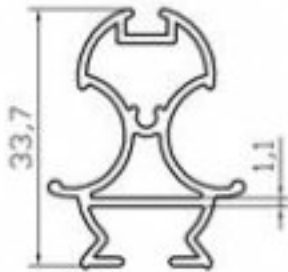
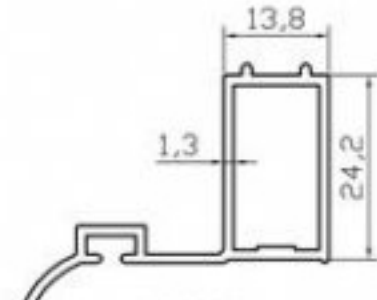
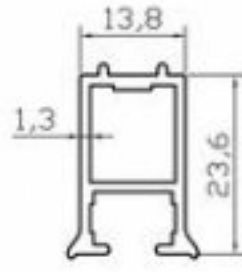
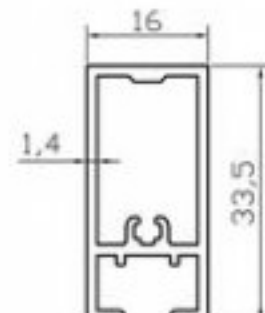
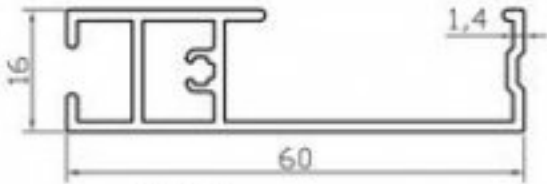
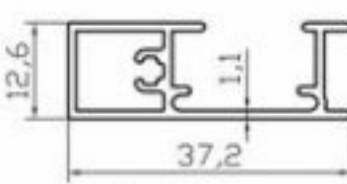
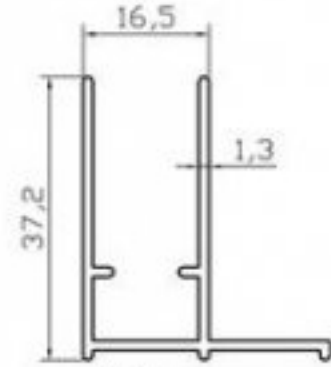

**DUŞAKABIN PROFİLLERİ
(SOFTLINE SERİ)**

K4400
FİTİLSİZ DİKME
(0.215 Kg/m)

K4401
FİTİLLİ DİKME
(0.215 Kg/m)

K4424
ARA FİTİLLİ DİKME
(0.245 Kg/m)

K4402
FİTİLLİ DİKME (KAYAR)
(0.420 Kg/m)

K4403
FİTİLLİ KÖŞE
(0.420 Kg/m)

K4404
KAPI KARŞILIĞI
(0.440 Kg/m)

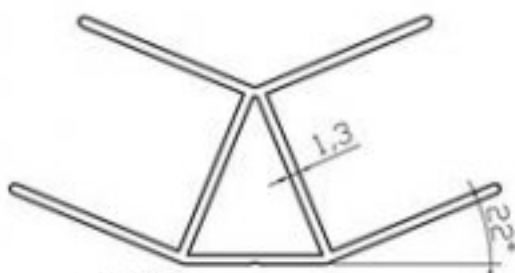
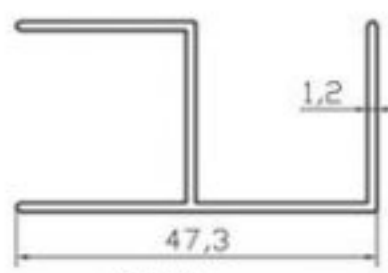
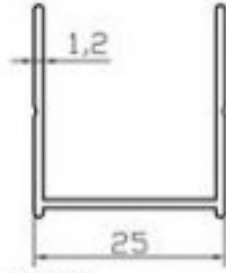
K4405
SABİT DİKME
(0.260 Kg/m)

K4406
ASKILIK PROFİLİ
(0.430 Kg/m)

K4408
ASKILIK PROFİLİ
(0.540 Kg/m)

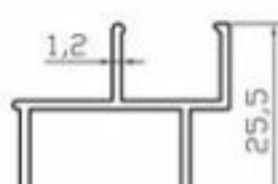
K4407
İÇ RAY PROFİLİ
(0.320 Kg/m)

K4409
DUVAR DİKME
(0.390 Kg/m)

* BELİRTİLEN AĞIRLIKLAR, TEORİK PRES ÇIKIŞ AĞIRLIKLARDIR
* THE WEIGHTS ARE THEORETICAL OF PRESSED PROFILES.

113

* ÖLÇEK / SCALE : 1/1

**DUŞAKABIN PROFİLLERİ
(HIGHLINE SERİ)**

K4410
KÖŞE PROFİLİ
(135°) (0.570 Kg/m)

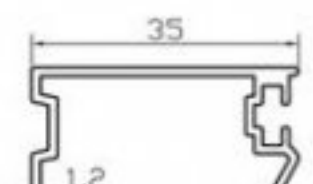
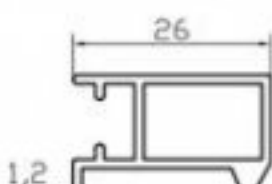
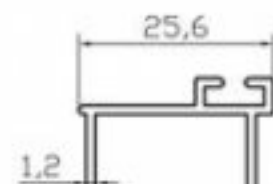
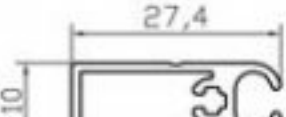
K4411
DİKME BAĞLANTI
(0.395 Kg/m)

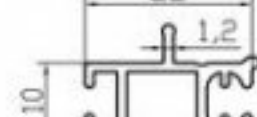
K4412
DUVAR DİKME PROFİLİ
(0.240 Kg/m)

K4413
GÖNYELİ DUVAR DİKME
(0.260 Kg/m)

K4414
KAPI KARŞILIĞI
(0.225 Kg/m)

K4415
DUVAR DİKME PROFİLİ
(0.200 Kg/m)

K4416
DIŞ RAY PROFİLİ
(0.325 Kg/m)

K4417
İÇ RAY PROFİLİ
(0.310 Kg/m)

K4425
KAPI KARŞILIĞI
(0.225 Kg/m)

K4418
SABİT DİKME
(0.290 Kg/m)

K4419
FİTİLSİZ DİKME
(0.300 Kg/m)

K4420
FİTİLLİ DİKME
(0.320 Kg/m)

K4421
KÖŞE FİTİLLİ DİKME
(0.325 Kg/m)

K4422
FİTİLLİ DİKME
(0.355 Kg/m)

K4423
ASKILIK PROFİLİ
(0.355 Kg/m)

* BELİRTİLEN AĞIRLIKLAR, TEORİK PRES ÇIKIŞ AĞIRLIKLARDIR
* THE WEIGHTS ARE THEORETICAL OF PRESSED PROFILES.

114

* ÖLÇEK / SCALE : 1/1

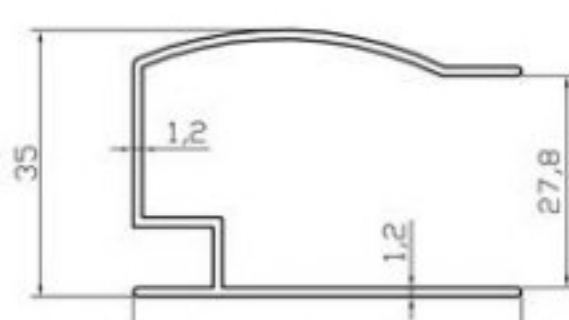
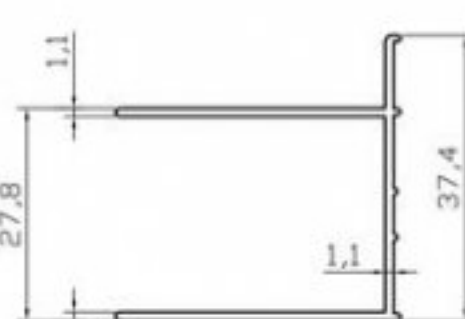
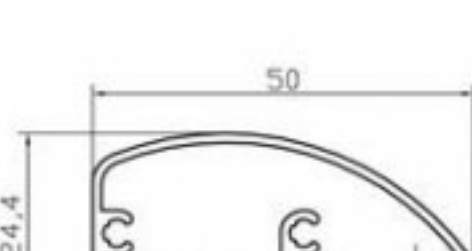
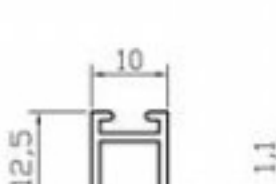
DUŞAKABIN PROFİLLERİ

K4426
CAM DİKME PROFİLİ
0.470 Kg/m

K4427
DUVAR DİKME PROFİLİ
0.340 Kg/m

K4428
RAY PROFİLİ
0.580 Kg/m

K4429
FİTİLLİ ÇİTA
0.140 Kg/m

* BELİRTİLEN AĞIRLIKLAR, TEORİK PRES ÇIKIŞ AĞIRLIKLARDIR
* THE WEIGHTS ARE THEORETICAL OF PRESSED PROFILES.

115

* ÖLÇEK / SCALE : 1/1